

1

Kit 5076





OPEL Crossland X, 5-dr SUV, 18-
VAUXHALL Crossland X, 5-dr SUV, 18-

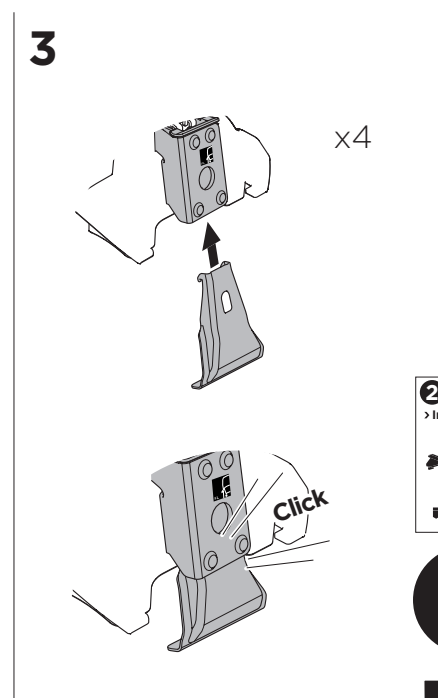
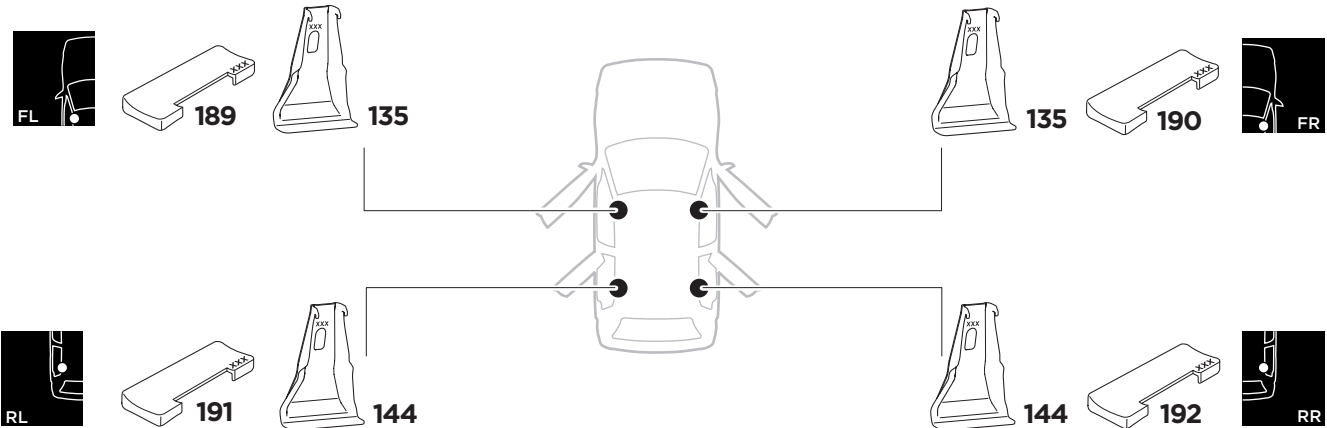
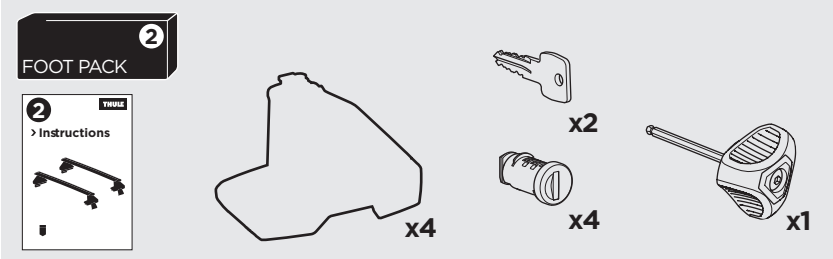
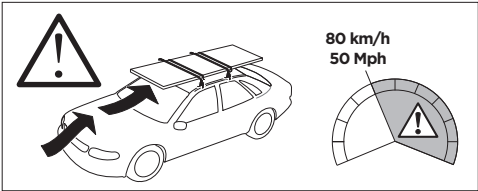
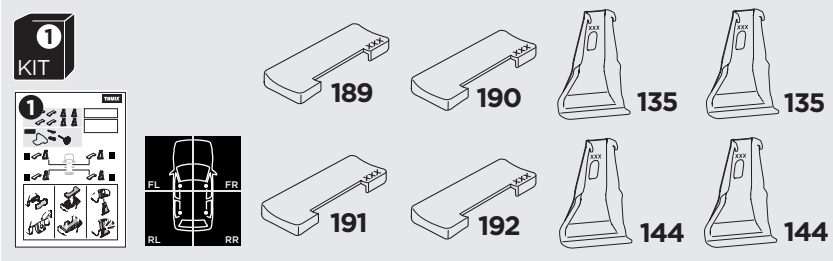



ISO 11154-E









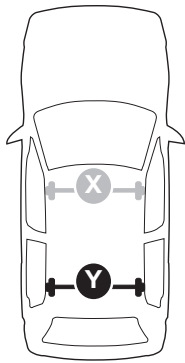

 THULE WingBar Evo  THULE WingBar Edge  THULE WingBar  THULE SquareBar	Evo X (scale)	Edge X (scale)
OPEL Crossland X, 5-dr SUV, 18-	40,5	P
VAUXHALL Crossland X, 5-dr SUV, 18-	40,5	P

 THULE ProBar  THULE SlideBar	X (mm/inch)
OPEL Crossland X, 5-dr SUV, 18-	1056 mm / 41 5/8"
VAUXHALL Crossland X, 5-dr SUV, 18-	1056 mm / 41 5/8"



 THULE WingBar Evo  THULE WingBar Edge  THULE WingBar  THULE SquareBar	Evo Y (scale)	Edge Y (scale)
OPEL Crossland X, 5-dr SUV, 18-	35	I
VAUXHALL Crossland X, 5-dr SUV, 18-	35	I

 THULE ProBar  THULE SlideBar	Y (mm/inch)
OPEL Crossland X, 5-dr SUV, 18-	1001 mm / 39 3/8"
VAUXHALL Crossland X, 5-dr SUV, 18-	1001 mm / 39 3/8"

	W (mm/inch)	Z (mm/inch)
OPEL Crossland X, 5-dr SUV, 18-	725 mm / 28 1/2"	220 mm / 8 5/8"
VAUXHALL Crossland X, 5-dr SUV, 18-	725 mm / 28 1/2"	220 mm / 8 5/8"

